

8830 N

AC axial compact fan



ebm-papst St. Georgen GmbH & Co. KG

Hermann-Papst-Str. 1
D-78112 St. Georgen
Phone +49 (0) 7724 81-0
Fax +49 (0) 7724 81-1309
info2@de.ebmpapst.com
www.ebmpapst.com

Nominal data

Type	8830 N	
Phase		1~
Nominal voltage	VAC	115
Frequency	Hz	60
Speed	min ⁻¹	1950
Power input	W	8.0
Min. ambient temperature	°C	-10
Max. ambient temperature	°C	80
Air flow	m ³ /h	36
Sound power level	B	3.7
Sound pressure level	dB(A)	21

ml = Max. load · me = Max. efficiency · fa = Running at free air · cs = Customer specs · cu = Customer unit
Subject to alterations



Technical features

Mass	0.490 kg
Dimensions	80 x 80 x 38 mm
Material of impeller	Metal
Housing material	Metal
Direction of air flow	Air exhaust over bars
Direction of rotation	Right, looking at rotor
Bearing	Sintec sleeve bearing system
Lifetime L10 at 40 °C	62500 h
Lifetime L10 at maximum temperature	25000 h
Connection line	2 single strands AWG 18, TR 64
Motor protection	Protected from overload using impedance protection
Approval	VDE, CSA, UL, CE

Product drawing

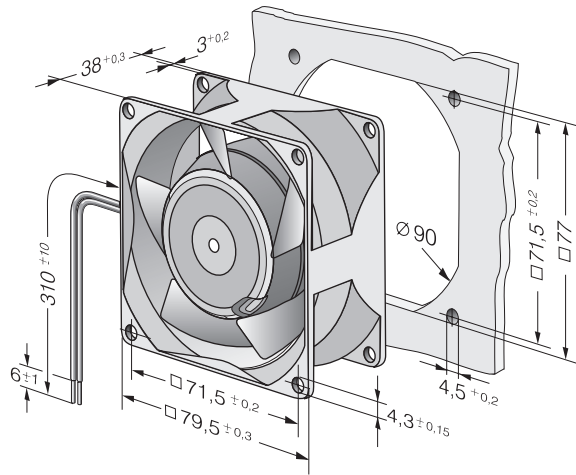

Charts: Air flow

